

手指伸展訓練器

Finger Stretching Trainer

使用說明書

Instruction Manual



(SKD)

Ziglite Smart Health Care Products Co., Ltd.

節亮康護產品有限公司

目 錄

了解產品	02
使用指南	04
安全注意事項	10
產品使用注意事項	11
故障排除	13
技術參數	14
售後服務	15

感謝您選購手指伸展訓練器。

使用本產品之前，請仔細閱讀本說明書。

請妥善保管本說明書，以便在使用訓練器時予以指導。

手指伸展訓練器可提供手部循環和鏡像運動康復訓練，維持並擴大用戶手指關節活動度，防止關節攣縮、肌肉萎縮，對神經系統的重組和代償有極大的促進作用，幫助患者儘快康復。

腦卒中後手功能障礙的恢復是一個長期並且艱苦的過程不同患者的病情，康復療程和療效是有很大差別的。正常情況下手功能的恢復要比其他部位慢一些，需要長期堅持康復訓練。

如果您在使用中有疑問，請聯系：info@ziglite.com

說明書版本可能因軟體版本或者技術規格的變更而陞級，恕不另行通知。

了解產品

適用範圍

適用於受傷後患者的手指關節恢復或由腦損傷、腦卒中、腦癱、脊髓損傷、骨科術後、多發性硬化等引起的肢體障礙後遺症患者在家中及機構中的康復訓練。

產品組成

訓練器主機

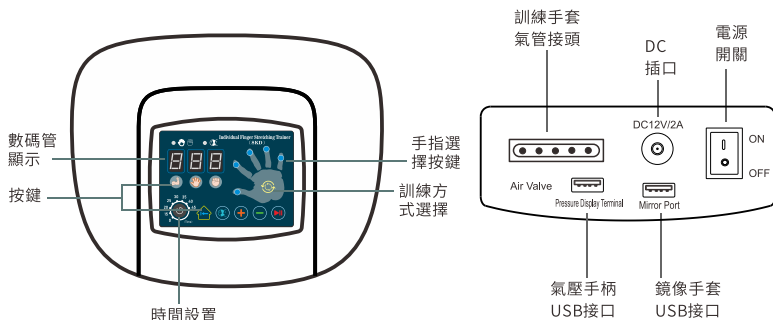

了解產品

訓練手套

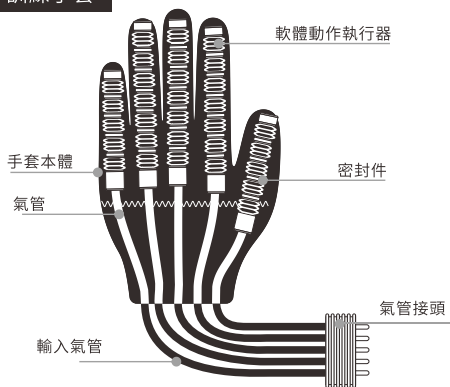

鏡像手套

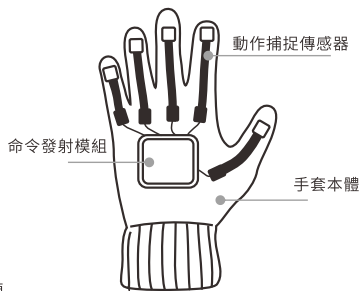

電源適配器





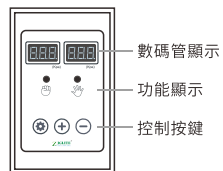

壓力手柄



使用指南

訓練器操作按鍵及界面詳解





1      **訓練/鏡像模式顯示**

默認為訓練模式

左邊圖顯示是訓練模式的工作狀態指示；
右邊的圖顯示是鏡像模式的工作狀態指示。
(均為綠色亮表示為當前該模式狀態)

2 **力量等級顯示&力量設置**

 按此按鍵可對訓練力量等級進行設置，上方對應的功能顯示數碼管會閃爍，此時可通過“+”“-”鍵來設置，設置範圍1~9檔。



默認為9檔

3 **手指張開時間等級顯示&設置**

 按此按鍵可對手指張開時間等級進行設置，上方對應的功能顯示數碼管會閃爍，此時可通過“+”“-”鍵來設置，設置範圍1~9檔。



默認為1檔

4 **手指收縮時間等級顯示&設置**

 按此按鍵可對手指收縮時間等級進行設置，上方對應的功能顯示數碼管會閃爍，此時可通過“+”“-”鍵來設置，設置範圍1~9檔。

默認為1檔

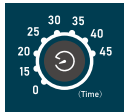
5 **訓練時間顯示&時間設置**

 該旋鈕可進對訓練時間進行設置，設置範圍15~45分鐘，分度值為5分鐘。

使用指南

訓練器操作按鍵及界面詳解



6

返回按鍵



開機時按此鍵可使機器在任意模式下返回到初始開機默認模式的狀態。

7

鏡像模式按鍵



按此鍵可進入/退出鏡像訓練模式。

8

“加”設置按鍵



按此鍵可對訓練力量、手指張開時間、手指收縮時間增加設置。

9

“減”設置按鍵



按此鍵可對訓練力量、手指張開時間、手指收縮時間減少設置。

10

開始/暫停按鍵



按此鍵可進行訓練開始及暫停設置。

使用指南

訓練器操作按鍵及界面詳解



11

訓練手指顯示&選擇



按此5個按鍵進行訓練手指選擇，藍色燈亮起時表示已經選中該手指訓練，當選定的手指LED燈不亮，則該手指不參與訓練計畫。

12

動作模式切換



按此按鍵進行動作模式切換：

- ①當手指上藍色LED燈全亮，表示處於5個手指一起訓練模式；
- ②當手指上藍色的LED燈如走馬燈樣亮，表示處於逐個手指訓練模式。

注：訓練模式通過程式控制對手指進行時間錯位操控，即首先會控制拇指外的四根手指先收縮，拇指會延遲2秒收縮，優點是避免5根手指同時收縮時會造成拇指和食指互相頂住，影響訓練效果。

使用指南

使用方法

1



放置好訓練器主機

將訓練器主機放在桌面，請勿放在潮濕、軟布面、不潔淨的桌面。

2



連接氣管和DC插頭

訓練手套接入時需將氣管接頭卡入到主機對應接口。

3



穿戴訓練（鏡像）手套

監護人幫患者戴好手套，將手套魔術貼拉至腕部粘合收緊。

4



訓練器開機

向下撥動訓練器主機“電源開關”鍵到“ON”位置通電開啟，顯示屏點亮，進入。

5



開始手部訓練

設置好訓練需求，按“開始/暫停”按鍵隨時開始和暫停訓練。

6



訓練器關機

訓練結束，訓練器主機“電源開關”鍵撥到“OFF”位置斷電。

使用指南

手套接入主機圖示

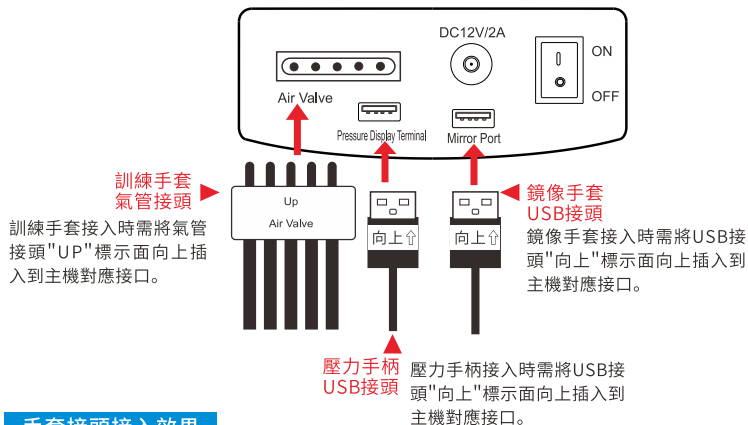

手套接頭接入效果



使用指南

氣閥開關控制



1 數碼管顯示

2 功能顯示

3 控制按鍵

1

壓力顯示:

收縮壓力量程設定範圍 $0-100\text{KPa} \pm 10\%$;
張開壓力量程範圍設定 $0-60\text{KPa} \pm 10\%$;
分度值: 1KPa 。

2



手指收縮壓力進行設置顯示, 上方對應的功能指示燈亮綠燈, 此時可通過“+”“-”鍵來設置, 設置範圍 $0-100\text{KPa} \pm 10\%$ 。



手指張開壓力進行設置顯示, 上方對應的功能指示燈亮綠燈, 此時可通過“+”“-”鍵來設置, 設置範圍 $0-60\text{KPa} \pm 10\%$ 。

3

壓力設定功能選擇



當主機通電開機, 這時手柄的開機默認壓力數值為最大數值狀態, 按此鍵可設置張開/收縮壓力大小。





“加”設置按鍵

按此鍵可對訓練壓力遞增設置。



“減”設置按鍵

按此鍵可對訓練壓力減少設置。

- 注:**
1. 當主機通電開機, 手柄也同步開機顯示, 這時手柄的開機默認壓力數值為最大數值狀態;
 2. 當按下  進入壓力設置模式, 無論是否有沒進入設置修改, 均會以壓力手柄顯示設置值運行! 如要退出及取消壓力手柄操作可按  鍵, 如需從新進入壓力手柄操作模式請再次按下壓力手柄的  按鍵;
 3. 在進入運行壓力手柄模式時, 主機上的力量等級鍵會被封閉, 不能操作。

安全注意事項

【警告】不遵守以下安全說明，可能會導致火災、電擊、傷亡等嚴重事故。

- 請勿自行拆卸或修理、改造設備的各部件避免引起訓練器出現異常。
- 請勿在熱水器、微波爐、煮食設備或高壓容器內部或附近存放各部件，避免因過熱而引起火災。
- 不可以滅菌或高壓滅菌。
- 請勿在出現報警提示時繼續使用。
- 適用於手部循環和鏡像運動康復訓練，請勿用於其他目的，避免引起事故發生。
- 請勿將各部件存放在過熱或過冷的地方，避免引起事故發生。
- 產品的有效期為5年，產品在使用壽命末期的處理應符合當地法律法規要求。
- 請保持電源接頭乾燥無水，請不要用濕手去插拔電源，避免引起觸電或受傷。

工作環境

- 1) 環境溫度:10°C~35°C
- 2) 相對濕度:30%~75%，不包含冷凝
- 3) 大氣壓力範圍:700hpa~1060hpa
- 4) 電源:AC100-240V, 50/60Hz (訓練器主機電源DC12V)

存放運輸

- 在運輸過程中，請將訓練器固定在相對穩定的地方，防止訓練器的磕碰和損壞。
- 請防止液體或異物進入訓練器，避免損傷內部電子部件，引起故障。
- 請勿在消毒氣體或活性氣體的環境中存放，避免損傷內部電子部件，引起故障。
- 請勿長時間放置在日光或紫外線等強光照射場所，避免引起外殼變色。
- 請勿把本產品放置在嬰幼兒可觸及的地方。
- 保存產品時，請勿在產品上放置其他物品。
- 請勿讓產品觸及釘子、針頭等鋒利物體。
- 請勿將手套強力折疊，避免損傷軟體作動執行器，引起故障。
- 請勿在潮濕環境或強磁場干擾等不適合電子設備工作環境中存放訓練器。

後期處理

- 請勿將訓練器置入火中銷毀。
- 請勿將訓練器作為普通的生活垃圾處理，終末期按照醫療器械標準要求處理，勿隨意丟棄。

產品使用注意事項

- 產品使用過程中如發生皮膚過敏等不適，請停止使用，並諮詢醫生。
- 有疾病或傷口或因此正在接受治療的患者，或者有過既往病史的，請熟知以下內容後，諮詢醫生。
- 如手部有扭傷、創傷、情況不明的骨傷、嚴重骨質酥鬆人群、骨折未經處理或處理後需要制動的人群，在未經專業人員確定可用的情況下，請勿擅自使用本產品。

禁忌症

- 有胸部靜脈瘤等重度血行障礙和患有血栓症的患者。
- 患側手上有潰瘍、傷口、膿瘻、出血、燙傷、炎症等的患者。

其他使用注意事項

- 1) 使用過程中體驗感或身體感到異常時，應停止使用並就醫後在醫生的指導下使用；
- 2) 使用過程中出現發紅、瘙癢、斑疹等，應停止使用並就醫；
- 3) 請勿與其他裝備同時使用或塗抹藥物的狀態下使用；
- 4) 請勿給無行為意識的人或幼童獨自使用；
- 5) 請勿將本產品用於使用目的之外的其他用途。

使用前

- 1) 在穿戴訓練手套前，請試運行訓練器主機1分鐘以確認各部分功能正常；
- 2) 強制性收縮痙攣患者，使用訓練器前，需先做按摩活動後再使用；
- 3) 注：訓練前請確認需要訓練的手部非肌張力過高（II級以上），方可進行訓練。

產品使用注意事項

使用中

運行過程中發生以下情況，請立即停止使用，並斷開電源！

- 1) 訓練器主機發出異常聲音；
- 2) 訓練器主機表面溫度過高；
- 3) 訓練器主機進水；
- 4) 使用者感到疼痛腫脹或者其他不適症狀；
- 5) 訓練過程中如有痙攣發生應立即停止使用。

使用時間

- 1) 建議根據自身實際情況，選擇合適的訓練方式；
- 2) 每次使用時間不宜過長，訓練後第二天手部如果有酸痛感，則需減少每天訓練次數和時間；
- 3) 建議每天使用2-4次，每次15分鐘左右，備次使用間隔至少45分鐘以上；
- 4) 使用時若需要更換或延長使用時間請諮詢專業醫護人員；
- 5) 單次使用時間控制在20分鐘內，再次使用前需保證機器充分冷卻，至少間隔45分鐘以上；長時間連續使用會容易導致機器內部溫度過高，可能出現休眠或動作不同步等現象，待機器充分冷卻後會自動恢復正常。

電源適配器的使用

- 1) 電源適配器必須有患者監護人插拔使用；
- 2) 訓練器使用完畢後，請將電源適配器與220V電源斷電；
- 3) 請勿使用非本機配備的電源適配器。

故障排除

問題	原因	措施
向下撥動“電源開關”開不了機	電源接觸不良	檢查電源線與電源適配器及電源適配器與主機連接情況
訓練手套無法正常工作	訓練手套未正常接入訓練器主機或訓練手套結構破損	檢查訓練手套物理狀態及訓練器主機和訓練手套連接情況

注：用上述方法若仍舊無法正常使用時，請與節亮康復產品有限公司聯繫。

保養和維護

清潔消毒

- 訓練手套和鏡像手套請勿放到水裏浸泡清潔或放置到洗衣機內清洗，可將軟布蘸水或中性洗滌劑，充分擰幹後擦拭手套。必要時可用蘸取少量濃度為75%醫用酒精的抹布進行清洗或消毒，於陰涼通風處晾乾後再使用。
- 在訓練器主機表面出現灰塵或污垢時，用戶可用濃度為75%醫用酒精擦拭。擦拭時請用乾爽的布蘸取少量酒精，避免讓酒精滴入或流入產品中。
- 用潔淨、乾爽的軟布清潔，陰涼通風處自然風乾。

⚠ 注意：

- 使用酒精以外的清潔消毒劑可能損壞產品，縮短使用壽命或者導致安全風險。
- 禁止使用高溫烘乾和放置於太陽下暴曬等進行速幹或消毒操作。
- 不能使用汽油、稀釋劑或類似的有機溶劑對本產品的任何部位進行清洗。切勿使用放射、蒸汽、環氧乙烷等方法進行消毒，否則會造成產品損壞。

技術參數

產品規格

產品名稱	手指伸展訓練器	進液防護程度	IPX0
產品型號	SKD	力度設定	1-9檔
安全類型	I 型	時間設定	15-45分鐘
電 源	AC100-240V, 50/60Hz	運行噪音	≤60分貝
主機尺寸	251*204*111mm	訓練模式	循環訓練/鏡像訓練/分指訓練

手套尺碼錶

尺碼	S	M	L	XL	XXL
手長 (mm)	140-160	160-180	165-190	190-220	220-230
手寬 (mm)	60-80	70-90	80-100	100-120	120-130
中指圍 (mm)	45-50	50-60	60-70	70-90	90-100

- 可根據使用者實際手部量測情況選擇對應型號如兩個及以上測量值處於臨界點，建議選備大一碼。
- 女士一般選擇S/M，男士一般選擇L/XL，手大者XXL。

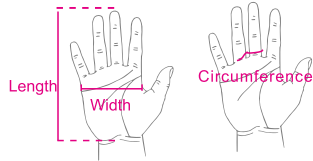

售後服務

售後電郵: info@ziglite.com

售後地址: 香港新界荃灣沙咀道364 - 366 號, 萬象工業大廈 18/F B3室

裝箱清單		
序號	名稱	數量
1	訓練器主機	1臺
2	訓練手套	1隻
3	鏡像手套	1隻
4	壓力控制手柄	1個
5	電源適配器 電源線	1個
6	產品說明書	1份
7	USB數據線	2條

Contents

Product Introduction	02
User Guide	04
Safety Precautions	13
Safety Precaution Include	14
Troubleshooting	16
Technical Parameters	17
CustomerService	18

After service, Thank you for choosing the finger trainer.

Please read this manual carefully before using this product.

Please keep this manual properly for guidance when using the stretching trainer.

The finger training device has two modes: the passive mode and mirror training mode. Our device aims to maintain and expand the range of motion of finger joints, prevent joint contracture and muscle atrophy, greatly promote the reorganization and compensation of the nervous system, and help patients recover as soon as possible.

The recovery of hand dysfunction after stroke is a long-term and arduous process. Patients' conditions, rehabilitation courses, and curative effects are very different. Under normal circumstances, the recovery of hand function is slower than other parts, and long-term rehabilitation training is needed.

If you have any questions in use, please contact: info@ziglite.com

The manual version may upgrade due to changes in software version or technical specifications without prior notice.

Product Introduction

Scope Of Application

It is suitable for rehabilitation training in (families) institutions for patients with finger joint recovery after injury or limb dysfunction sequelae caused by brain injury, stroke, cerebral palsy, spinal cord injury, orthopedic surgery, multiple sclerosis, etc.

Product Composition

Trainer Host

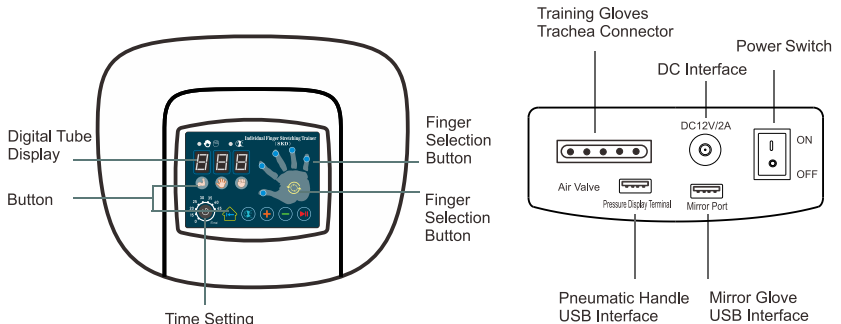

Product Introduction

Training Gloves

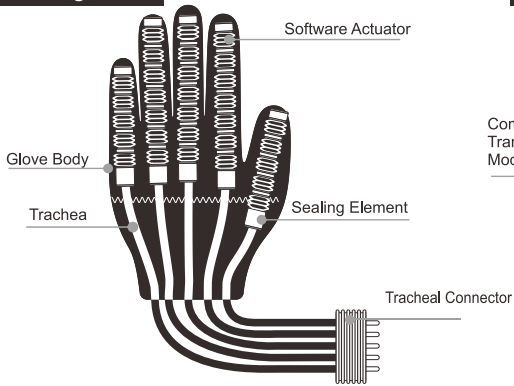

Mirror Glove

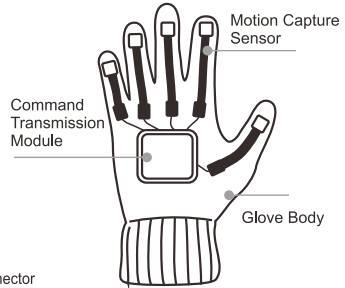

Power Adapter

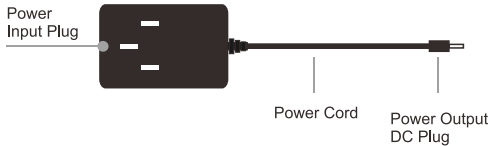

Pressure Handle

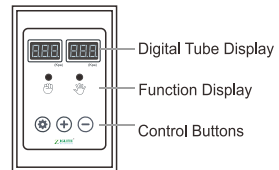

User Guide

Buttons, Screen Icons In Detail



1



default to training mode

Training/Mirror Mode Display

The left image shows the working status indication of the training mode;

The figure on the right shows the working status indication of mirror mode.

(All green lights indicate the current mode status)

2



default to 9th gear

Strength Level Display & Settings

Press this button to set the training strength level, and the corresponding function display above will flash on the digital tube. At this time, you can use the "+" and "-" keys to set the range from 1 to 9 gears.

User Guide

3



default to 1st gear

Finger Opening Time Level Display & Settings

Press this button to set the finger opening time level, and the corresponding function display above will flash on the digital tube. At this time, you can use the "+" and "-" keys to set the range from 1 to 9 gears.

4



default to 1st gear

Finger Contraction Time Level Display & Settings

Press this button to set the finger contraction time level, and the corresponding function display above will flash on the digital tube. At this time, you can use the "+" and "-" keys to set the range from 1 to 9 gears.

5

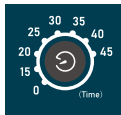

Training Time Display & Time Setting

This knob can be used to set the training time, with a range of 15-45 minutes and a graduation value of 5 minutes.

User Guide

Buttons, Screen Icons In Detail



6

Return Button



Press this key to return the machine to the default mode of initial startup in any mode.

7

Mirror Mode Button



Press this button to enter/exit the mirror training mode.

8

+ "Setting Button



Press this button to increase the settings for training strength, finger opening time, and finger contraction time.

9

- "Setting Button



Press this button to reduce the settings for training strength, finger opening time, finger contraction time, and training time.

10

Start / Pause button



Press this button to start and pause training settings.

User Guide

Buttons, Screen Icons In Detail

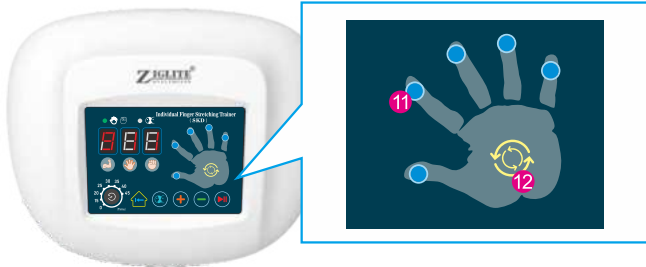

11



Training Finger Display&Selection

Press these 5 buttons to select training fingers. When the blue light is on, it indicates that the finger training has been selected. When the selected finger LED light is not on, the finger does not participate in the training plan.

12



Action Mode Switching

Press this button to switch the action mode:

- ① When the blue LED lights on the fingers are all on, it indicates that they are in the training mode of 5 fingers together;
- ② When the blue LED light on the finger lights up like a walking lantern, it indicates that it is in finger by finger training mode.

Note: The training mode controls the timing of fingers through program control, which first controls the four fingers outside the thumb to contract first, and the thumb will delay contraction by 2 seconds. The advantage is to avoid causing the thumb and index finger to press against each other when the five fingers contract at the same time, which affects the training effect.

User Guide

Use Guide



1 Place The Trainer Device Host

Place the training host on the desktop, not on the wet, soft cloth or unclean desktop.



2 Connect Air Pipe And DC Plug

When connecting the training gloves, it is necessary to clip the air pipe connector into the corresponding interface of the host.



3 Wear Training (Mirror) Gloves

The guardian shall help the patient wear gloves and pull the Velcro glove to the wrist to bond and tighten.

User Guide

Use Guide

4



Power On

Turn down the "power switch" button of the trainer host to the "ON" position to turn on the power, and the display screen will light up to enter.

5



Start Hand Training

Press the "cycle mode / mirror mode" button to start and pause training at any time.

6



Shut Off

After the training, turn the "power switch" button of the trainer host to the "OFF" position to power off.

User Guide

Glove Wiring Diagram

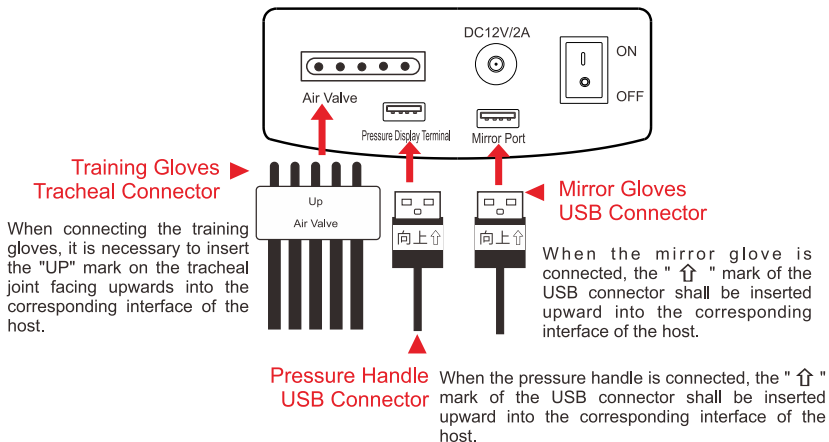

Glove Joint Insertion Effect



User Guide

Air Valve Switch Control

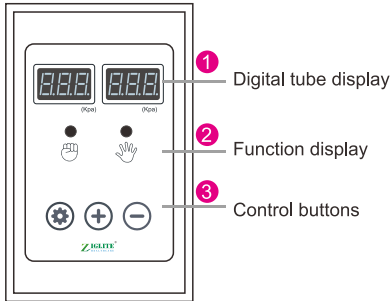

1 Digital tube display

2 Function display

3 Control buttons



1 Pressure display:
The set range of contraction pressure range is 0-100KPa \pm 10%;
Set the range of opening pressure range to 0-60KPa \pm 10%;
Graduation value: 1KPa.



2

 The finger contraction pressure is set and displayed, and the corresponding function indicator light above is green. At this time, the setting range can be 0-100KPa \pm 10% through the "+" and "-" keys.

 The finger opening pressure is displayed for setting, and the corresponding function indicator light above lights up green. At this time, the setting range is 0-60KPa \pm 10%, which can be set using the "+" and "-" keys.

User Guide

<p>3</p> <p>Pressure Setting Function Selection</p> <p> When the host is powered on and turned on, the default pressure value of the handle is the maximum value. Press this button to set the opening/retraction pressure.</p>	
<p>“+” Set Button</p> <p> Press this button to increase the training pressure setting.</p>	<p>“-” Set Button</p> <p> Press this button to reduce the training pressure setting.</p>

- Note:** 1. When the host is powered on and turned on, the handle will also be displayed synchronously. At this time, the default pressure value of the handle when turned on is the maximum value state;
2. When pressing "  " to enter the pressure setting mode, regardless of whether the setting has been modified or not, it will run with the set value displayed on the pressure handle! To exit and cancel the pressure handle operation, press the "  " button. To re-enter the pressure handle operation mode, press the "  " button of the pressure handle again;
3. When entering the operating pressure handle mode, the power level key on the host will be closed and cannot be operated.

Safety Precautions

[warning] Failure to comply with the following safety instructions may lead to severe accidents such as fire, electric shock, and casualties.

- Do not disassemble, repair, or modify the components of the equipment by yourself to avoid abnormalities in the treatment device.
- Do not store components in or near water heaters, microwave ovens, cooking equipment, or high-pressure containers to avoid fire caused by overheating.
- It cannot be sterilized or autoclaved.
- Do not continue to use it when the alarm prompt appears.
- It is suitable for hand circulation and mirror movement rehabilitation training. Please do not use it for other purposes to avoid accidents.
- Do not store the parts in a place that is too hot or cold to avoid accidents.
- The validity period of the product is five years, and the disposal of the product at the end of its service life should comply with the requirements of local laws and regulations.
- Please keep the power connector dry and water-free.
- Please do not plug in or unplug the power supply with wet hands to avoid electric shock or injury.

Working Environment

- 1) Ambient temperature: 10°C~35°C
- 2) Relative humidity: 30%~75%, excluding condensation
- 3) Atmospheric pressure range: 700hpa~1060hpa
- 4) Power supply: AC100~240V, 50/60Hz (trainer host power supply DC12V)

Storage And Transportation

- During transportation, please fix the trainer in a relatively stable place to prevent collision and damage to the trainer.
- Please prevent liquids or foreign objects from entering the trainer to avoid damaging internal electronic components and causing malfunctions.
- Please do not place it in places with strong sunlight or ultraviolet radiation for a long time to avoid causing discoloration of the shell.
- Do not place other items on the product when saving it.
- Do not fold the gloves forcefully to avoid damaging the soft-actuated actuator and causing malfunctions.
- Do not store the trainer in a humid environment or magnetic solid field interference unsuitable for working with electronic devices.

Safety Precaution Include

- In case of skin allergy and other discomfort while using the product, please stop using it and consult a doctor.
- In case of a sprain, trauma, bone injury of unknown condition, severe osteoporosis, untreated fracture, or people who need bracing after treatment, do not use this product without professional confirmation.
- For patients with diseases or wounds or being treated for them or with a previous medical history, please consult a doctor after becoming familiar with the following contents.

Contraindication

- Patients with severe blood flow disorder such as thoracic venous tumors and hemocolumn disease.
- Patients with ulcer, wound, purulent fruit, bleeding, scald, inflammation, etc.

Other Precautions

- 1) In case of abnormal experience or body feeling during use, stop using it and use it under the guidance of a doctor after seeing a doctor;
- 2) In case of redness, pruritus and rash during use, stop use and seek medical attention;
- 3) Do not use it together with other equipment or in the state of applying drugs;
- 4) Do not use it alone for unconscious people or young children;
- 5) Do not use this product for any purpose other than the purpose of use.

Before Use

- 1) Before wearing training gloves, please try to run the therapeutic device host for 1 minute to confirm that all parts function usually;
- 2) Patients with mandatory systolic spasm need to massage before using the therapeutic device;
- 3) Note: before training, please confirm that the non muscle tension of the hand to be trained is too high (above grade II)

Safety Precaution Include

In Use

In case of the following conditions during operation, please stop using immediately and disconnect the power supply.

- 1) The trainer host emits abnormal sound;
- 2) The surface temperature of the trainer host is too high;
- 3) Water ingress into the trainer host;
- 4) Users experience pain, swelling, or other discomfort symptoms;
- 5) If any spasms occur during the training process, immediately stop using it.

Usage Time

- 1) Suggest selecting appropriate training methods based on one's actual situation;
- 2) The duration of each use should not be too long. If there is soreness in the hands the next day after training, it is necessary to reduce the number and duration of daily training;
- 3) It is recommended to use it 2-4 times a day, each time for about 15 minutes, with a minimum interval of 45 minutes between uses;
- 4) If it is necessary to replace or extend the use time during use, please consult professional medical personnel;
- 5) Long term continuous use can easily lead to high internal temperature of the machine, which may cause phenomena such as sleep or asynchronous movement. After the machine is fully cooled, it will automatically return to normal.

Use Of Power Adapter

- 1) The power adapter must be plugged and unplugged by a patient's supervisor;
- 2) After using the trainer, please disconnect the power adapter from the 220V power supply;
- 3) Do not use a power adapter that is not equipped with this machine.

Troubleshooting

Problem	The Reason	Measures
Flip the "power switch" down to turn on the machine	Poor power connection	Check the power cord and power adapter, the connection between the power adapter and the host
Training gloves are not working	Gloves that are not properly attached can damage the host or glove structure	Check the physical status of the training gloves and the connection between the trainer host and the training gloves

Note: If you still can't use the above method, please contact us.

Care & Maintenance

How to clean ?

- Do not wash training gloves and mirrored gloves directly with water. Dip a soft cloth in water or neutral detergent, wring it out, and wipe the gloves.
- When dust or dirt appears on the surface of the trainer host, users can use medical alcohol with a concentration of 75% to wipe it. When wiping, please dip a small amount of alcohol into a dry cloth to avoid allowing alcohol to drip or flow into the product.
- Clean with clean and dry soft cloth, and dry in a cool and ventilated place.

Note

- The use of cleaning and disinfecting agents other than alcohol may damage the product, shorten the service life or cause safety risks.
- It is forbidden to use high-temperature drying and exposure to the sun for quick drying or disinfection.
- Do not use gasoline, thinner or similar organic solvents to clean any part of this product. Do not use radiation, steam, ethylene oxide and other methods for disinfection, otherwise the product will be damaged.

Technical Parameters

Product Specifications

Product Name	Finger Stretching Trainer	Waterproof Level	IPX0
Product Model	SKD	Force Setting	1-9
Security Type	I Type	Time Setting	15-45 Minutes
Power Supply	AC100-240V 50/60Hz	Running Noise	≤60dB
Size	251*204*111mm	Training Mode	Cycle Training/ Mirror Training/Finger Selection Training

Glove Size

Size	S	M	L	XL	XXL
Hand Length (mm)	140-160	160-180	165-190	190-220	220-230
Hand Width (mm)	60-80	70-90	80-100	100-120	120-130
Middle Finger Circumference (mm)	45-50	50-60	60-70	70-90	90-100

- The corresponding model can be selected according to the actual hand measurement of the user. If two or more measured values are at the critical point, it is recommended to select one size larger.
- Women generally choose s/m, men generally choose l/xl, and the larger hand is XXL.

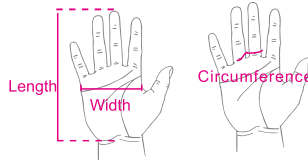

Customer Service

Email : info@ziglite.com

Address : Room B3, 18/F Bonsun Industrial Building,364-366 Sha Tsui Road,
Tsuen Wan, Hong Kong

Packing List		
Number	Name	Quantity
1	Trainer Host	1 pcs
2	Training Gloves	1 pcs
3	Mirror Gloves	1 pcs
4	Pressure Control Handle	1 pcs
5	Power Adapter Power Cord	1 pcs
6	Product Manual	1 pcs
7	USB Data Cable	2 pcs



Ziglite Smart Health Care Products Co., Ltd.
節亮康護產品有限公司

Office Address : Room B3, 18/F Bonsun Industrial Building, 364-366 Sha Tsui Road, Tsuen
Wan, Hong Kong

Email : info@ziglite.com

Fax: +852 3544 0462

Office Tel : +852 3107 7500

Whatsapp : +852 6827 2010

NO. SKD02-CH-EN